

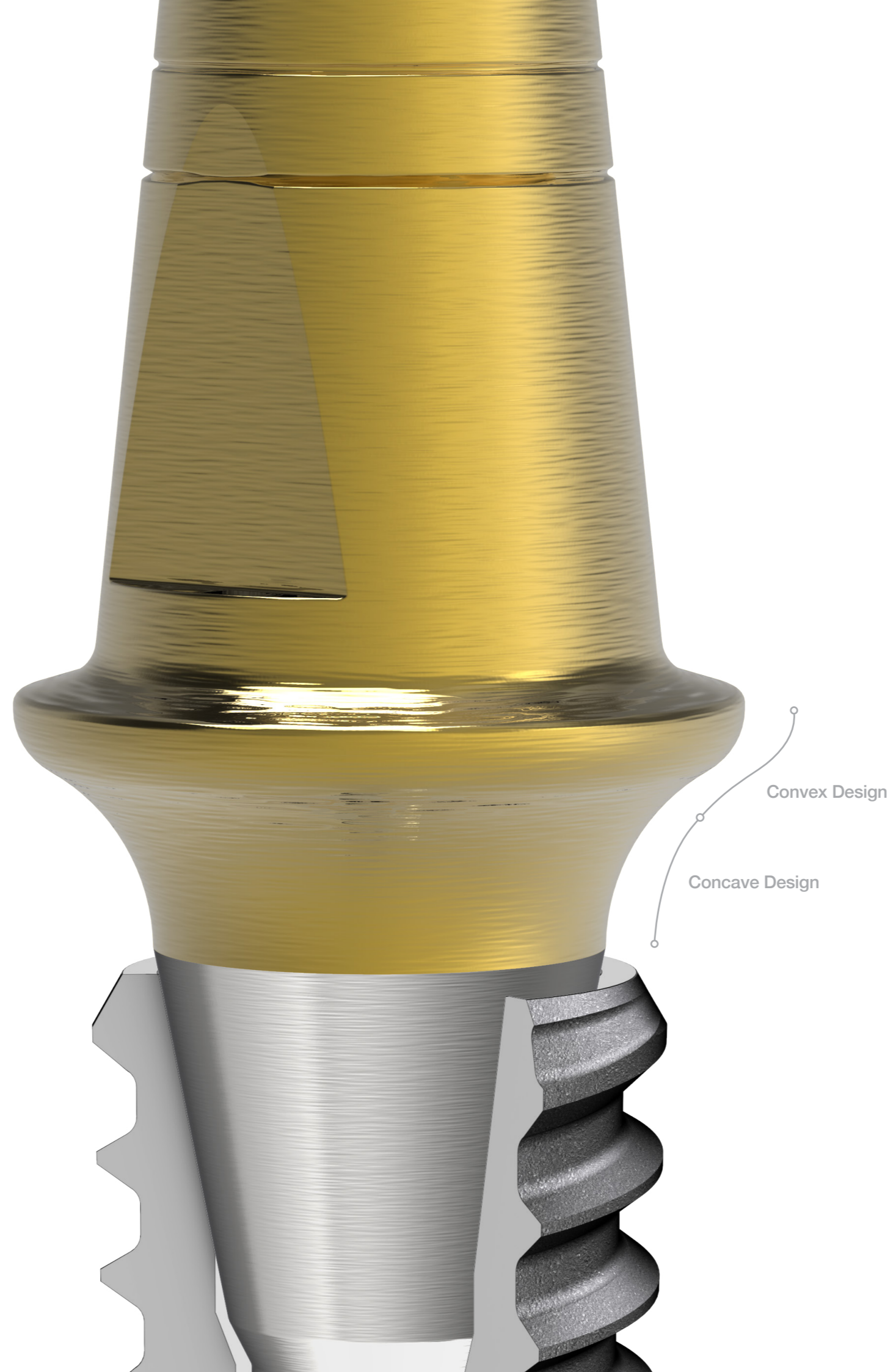

S-LINE ABUTMENT

www.dentisimplant.co.kr



Tel. +82-1899-2804 | Fax. +82-53-583-2806
99, Seongseoseo-Ro, Dalseo-Gu, Daegu, Korea



Tel. +1-323-677-4363 | Fax. +1-323-677-4366
6 Centerpointe Drive, Suite 600 La Palma CA 90623



Tel. +021-5111-3828 | Fax. +021-5111-3828
上海市长宁区中山西路933号2205室

©2019 DENTIS Co.,Ltd. All Right Reserved.
Specifications are subject to change without notice.
Trademarks are the property of DENTIS Co., Ltd. Or their respective owners.
D-C-SLA-V1-201903-ENG

S-Line Characteristics

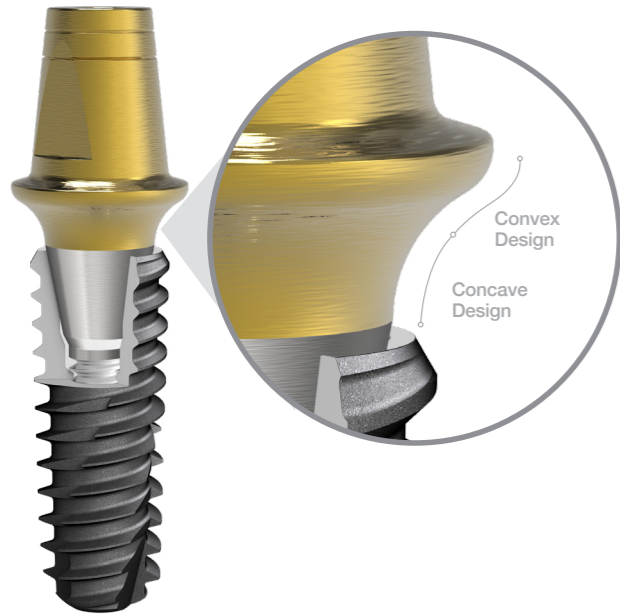

S-Line Abutment

Creates natural and functional emergence profile

- Prevents bone loss by avoiding interference with alveolar bone and increases the volume of the soft tissue around implant.
- Prevents infection from such food particles.
- Increases aesthetic value.



Abutment Package

Regular/Wide

s-Clean
 TiN Half Coating
 Angled Abutment, S-Line
(01)08806189115454(11)180618(10)17C369A
 제품명 (Product) **Dental Implant System**
 치과용 임플란트 상부 구조물 (의료기기)
 REF 모델 **DSAAZ55154HCTS**
 규격 (Size) **Ø5.5, C:4.0mm, 15°**
 타입 (Type) **s-Clean, Hex**
 LOT 제조번호 **17C369A**
 제조일자 **2018.06.18**
 유효기간 **N/A**
 포장단위 **1SET**
 품목허가번호 **제인06-190호**
 일회용 의료기기 / 재사용금지
 실온보관 / Storage at room temperature.
 LPABSC08130117C369A
 AL01(R01)

Model

Size

Type

S-Line

Lot no.

Abutment Spec

Regular/Wide

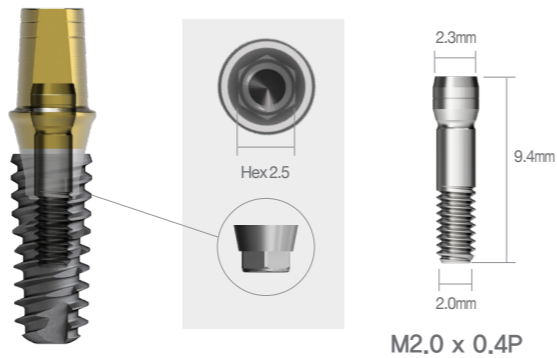

※ Recommended torque : 30Ncm

Healing Abutment

Regular / Wide

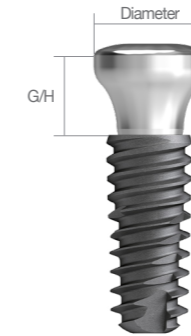

DSHZ5540 + DSSFR4010

| Abutment Diameter | G/H | Code No. |
|-------------------|-------|----------|
| Ø4.8 | 2.0mm | DSHZ4820 |
| | 3.0mm | DSHZ4830 |
| | 4.0mm | DSHZ4840 |
| | 5.0mm | DSHZ4850 |
| | 6.0mm | DSHZ4860 |
| | 7.0mm | DSHZ4870 |

| Abutment Diameter | G/H | Code No. |
|-------------------|-------|----------|
| Ø5.8 | 2.0mm | DSHZ5820 |
| | 3.0mm | DSHZ5530 |
| | 4.0mm | DSHZ5540 |
| | 5.0mm | DSHZ5550 |
| | 6.0mm | DSHZ4860 |
| | 7.0mm | DSHZ4870 |

| Abutment Diameter | G/H | Code No. |
|-------------------|-------|----------|
| Ø6.8 | 2.0mm | DSHZ6820 |
| | 3.0mm | DSHZ6830 |
| | 4.0mm | DSHZ6840 |
| | 5.0mm | DSHZ6850 |
| | 6.0mm | DSHZ6860 |
| | 7.0mm | DSHZ6870 |

| Abutment Diameter | G/H | Code No. |
|-------------------|-------|----------|
| Ø7.8 | 2.0mm | DSHZ7820 |
| | 3.0mm | DSHZ7830 |
| | 4.0mm | DSHZ7840 |
| | 5.0mm | DSHZ7850 |
| | 6.0mm | DSHZ7860 |
| | 7.0mm | DSHZ7870 |

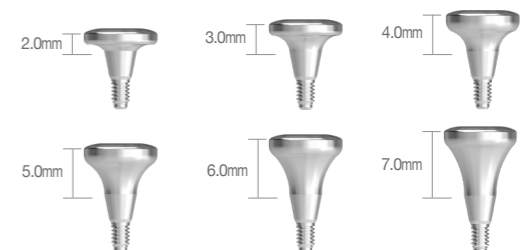
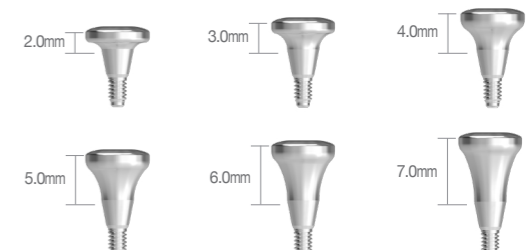
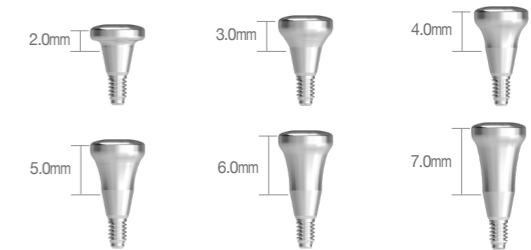
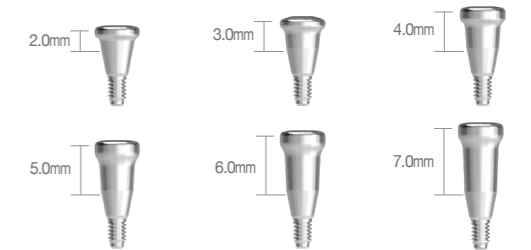

Sole Abutment

Regular / Wide

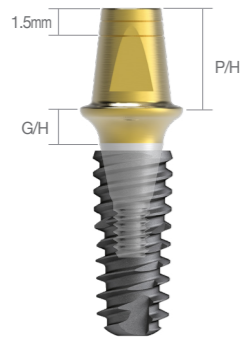

DSSAZ5520HCT + DSSFR4010

| Abutment Diameter | G/H | P/H | Code No. |
|-------------------|-------|-------|---------------|
| Ø4.5 | 2.0mm | 5.5mm | DSSAZ4520HCTS |
| | 3.0mm | | DSSAZ4530HCTS |
| | 4.0mm | | DSSAZ4540HCTS |
| | 5.0mm | | DSSAZ4550HCTS |
| | | | |

※ Set Code(S) : Abutment + Healing Cap[DSHC455]

| Abutment Diameter | G/H | P/H | Code No. |
|-------------------|-------|-------|---------------|
| Ø5.5 | 2.0mm | 5.5mm | DSSAZ5520HCTS |
| | 3.0mm | | DSSAZ5530HCTS |
| | 4.0mm | | DSSAZ5540HCTS |
| | 5.0mm | | DSSAZ5550HCTS |
| | | | |

※ Set Code(S) : Abutment + Healing Cap[DSHC555]

| Abutment Diameter | G/H | P/H | Code No. |
|-------------------|-------|-------|---------------|
| Ø6.5 | 2.0mm | 5.5mm | DSSAZ6520HCTS |
| | 3.0mm | | DSSAZ6530HCTS |
| | 4.0mm | | DSSAZ6540HCTS |
| | 5.0mm | | DSSAZ6550HCTS |
| | | | |

※ Set Code(S) : Abutment + Healing Cap[DSHC655]

| Abutment Diameter | G/H | P/H | Code No. |
|-------------------|-------|-------|---------------|
| Ø7.5 | 2.0mm | 5.5mm | DSSAZ7520HCTS |
| | 3.0mm | | DSSAZ7530HCTS |
| | 4.0mm | | DSSAZ7540HCTS |
| | 5.0mm | | DSSAZ7550HCTS |
| | | | |

※ Set Code(S) : Abutment + Healing Cap[DSHC755]

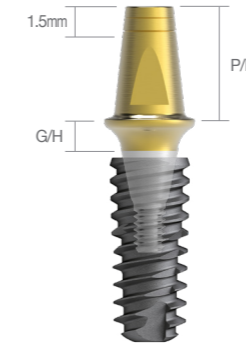
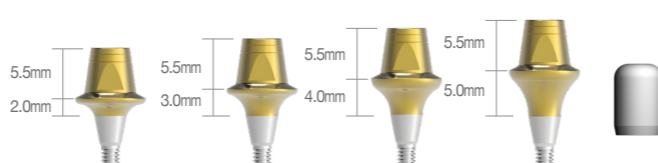
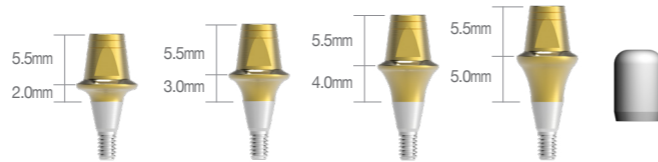
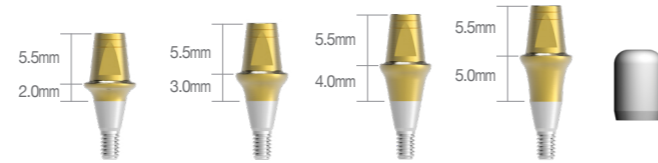
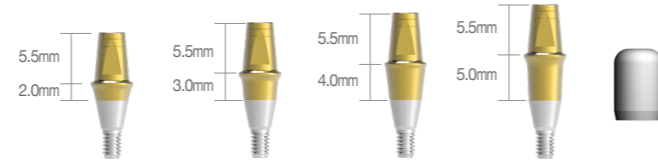

DSSAZ55207HCT + DSSFR4010

| Abutment Diameter | G/H | P/H | Code No. |
|-------------------|-------|-------|----------------|
| Ø4.5 | 2.0mm | 7.0mm | DSSAZ45207HCTS |
| | 3.0mm | | DSSAZ45307HCTS |
| | 4.0mm | | DSSAZ45407HCTS |
| | 5.0mm | | DSSAZ45507HCTS |
| | | | |

※ Set Code(S) : Abutment + Healing Cap[DSHC457]

| Abutment Diameter | G/H | P/H | Code No. |
|-------------------|-------|-------|----------------|
| Ø5.5 | 2.0mm | 7.0mm | DSSAZ55207HCTS |
| | 3.0mm | | DSSAZ55307HCTS |
| | 4.0mm | | DSSAZ55407HCTS |
| | 5.0mm | | DSSAZ55507HCTS |
| | | | |

※ Set Code(S) : Abutment + Healing Cap[DSHC557]

| Abutment Diameter | G/H | P/H | Code No. |
|-------------------|-------|-------|----------------|
| Ø6.5 | 2.0mm | 7.0mm | DSSAZ65207HCTS |
| | 3.0mm | | DSSAZ65307HCTS |
| | 4.0mm | | DSSAZ65407HCTS |
| | 5.0mm | | DSSAZ65507HCTS |
| | | | |

※ Set Code(S) : Abutment + Healing Cap[DSHC657]

| Abutment Diameter | G/H | P/H | Code No. |
|-------------------|-------|-------|----------------|
| Ø7.5 | 2.0mm | 7.0mm | DSSAZ75207HCTS |
| | 3.0mm | | DSSAZ75307HCTS |
| | 4.0mm | | DSSAZ75407HCTS |
| | 5.0mm | | DSSAZ75507HCTS |
| | | | |

※ Set Code(S) : Abutment + Healing Cap[DSHC757]

※ Sole/Couple Abutment G/H 6.0/7.0mm is coming soon.
Angled Abutment Flat type is coming soon.

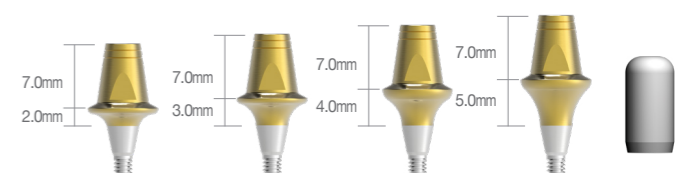
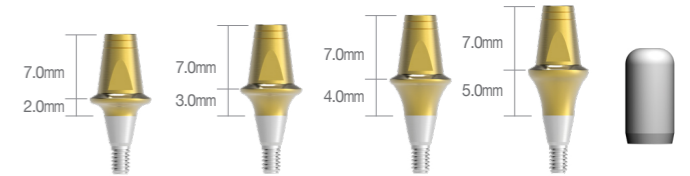
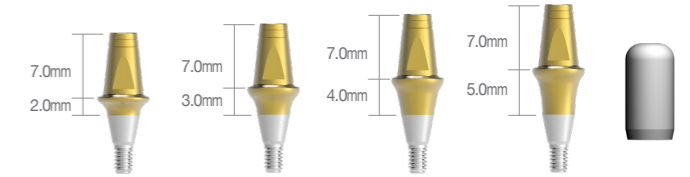
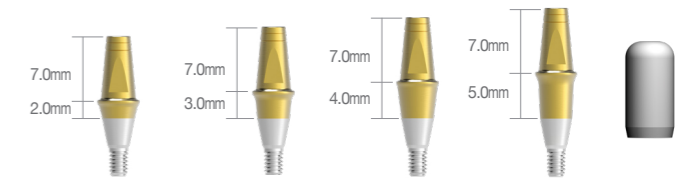

Sole Healing Cap

Regular / Wide

| Abutment Diameter | P/H | Code No. |
|-------------------|----------------|--------------------|
| Ø4.5 | 5.5mm 7.0mm | DSHC455 DSHC457 |
| Ø5.5 | 5.5mm 7.0mm | DSHC555 DSHC557 |
| Ø6.5 | 5.5mm 7.0mm | DSHC655 DSHC657 |
| Ø7.5 | 5.5mm 7.0mm | DSHC755 DSHC757 |

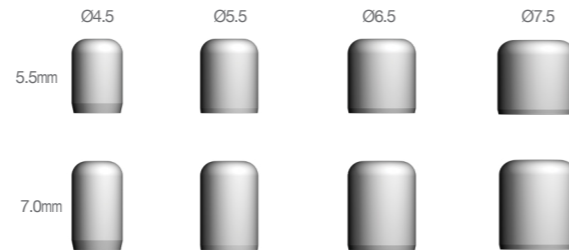

Abutment Screw

| Type | Code No. |
|----------------|---------------------------|
| Narrow | DSASS |
| Regular / Wide | DSAS / 2DSAS(S-Line only) |



※ Please pay attention not to use the S-Line abutment mixed with current DENTIS abutment.

Couple Abutment

Regular / Wide [Hex]

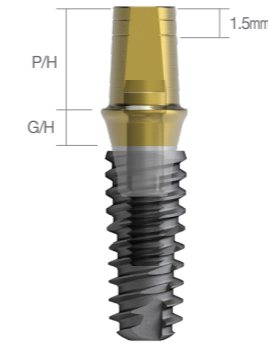

DSCAZ4520HHCT + DSSFR4010

| Abutment Diameter | G/H | P/H | Code No. |
|-------------------|-------|-------|----------------|
| Ø4.5 | 2.0mm | 5.5mm | DSCAZ4520HHCTS |
| | 3.0mm | | DSCAZ4530HHCTS |
| | 4.0mm | | DSCAZ4540HHCTS |
| | 5.0mm | | DSCAZ4550HHCTS |
| | | | |

※ Set Code(S) : Abutment + Abutment Screw[2DSAS]

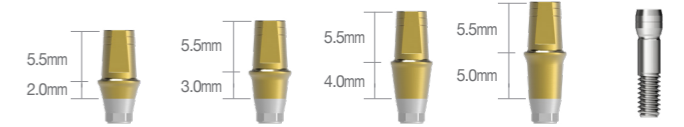

| Abutment Diameter | G/H | P/H | Code No. |
|-------------------|-------|-------|----------------|
| Ø5.5 | 2.0mm | 5.5mm | DSCAZ5520HHCTS |
| | 3.0mm | | DSCAZ5530HHCTS |
| | 4.0mm | | DSCAZ5540HHCTS |
| | 5.0mm | | DSCAZ5550HHCTS |
| | | | |

※ Set Code(S) : Abutment + Abutment Screw[2DSAS]

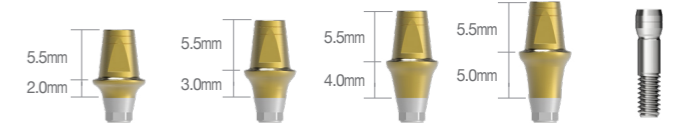

| Abutment Diameter | G/H | P/H | Code No. |
|-------------------|-------|-------|----------------|
| Ø6.5 | 2.0mm | 5.5mm | DSCAZ6520HHCTS |
| | 3.0mm | | DSCAZ6530HHCTS |
| | 4.0mm | | DSCAZ6540HHCTS |
| | 5.0mm | | DSCAZ6550HHCTS |
| | | | |

※ Set Code(S) : Abutment + Abutment Screw[2DSAS]



| Abutment Diameter | G/H | P/H | Code No. |
|-------------------|-------|-------|----------------|
| Ø7.5 | 2.0mm | 5.5mm | DSCAZ7520HHCTS |
| | 3.0mm | | DSCAZ7530HHCTS |
| | 4.0mm | | DSCAZ7540HHCTS |
| | 5.0mm | | DSCAZ7550HHCTS |
| | | | |

※ Set Code(S) : Abutment + Abutment Screw[2DSAS]

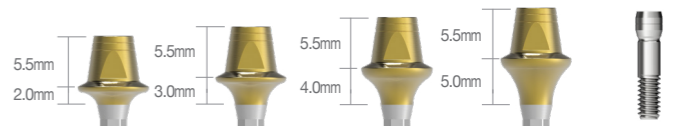

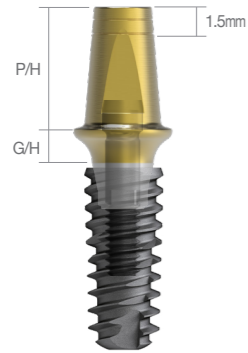

DSCAZ55207HHCT + DSSFR4010

| Abutment Diameter | G/H | P/H | Code No. |
|-------------------|-------|-------|-----------------|
| Ø4.5 | 2.0mm | 7.0mm | DSCAZ45207HHCTS |
| | 3.0mm | | DSCAZ45307HHCTS |
| | 4.0mm | | DSCAZ45407HHCTS |
| | 5.0mm | | DSCAZ45507HHCTS |
| | | | |

※ Set Code(S) : Abutment + Abutment Screw[2DSAS]

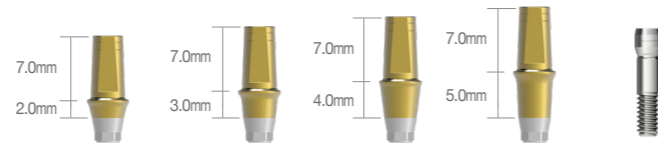

| Abutment Diameter | G/H | P/H | Code No. |
|-------------------|-------|-------|-----------------|
| Ø5.5 | 2.0mm | 7.0mm | DSCAZ55207HHCTS |
| | 3.0mm | | DSCAZ55307HHCTS |
| | 4.0mm | | DSCAZ55407HHCTS |
| | 5.0mm | | DSCAZ55507HHCTS |
| | | | |

※ Set Code(S) : Abutment + Abutment Screw[2DSAS]

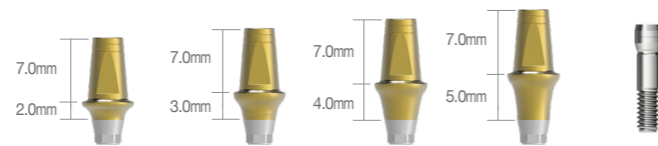

| Abutment Diameter | G/H | P/H | Code No. |
|-------------------|-------|-------|-----------------|
| Ø6.5 | 2.0mm | 7.0mm | DSCAZ65207HHCTS |
| | 3.0mm | | DSCAZ65307HHCTS |
| | 4.0mm | | DSCAZ65407HHCTS |
| | 5.0mm | | DSCAZ65507HHCTS |
| | | | |

※ Set Code(S) : Abutment + Abutment Screw[2DSAS]

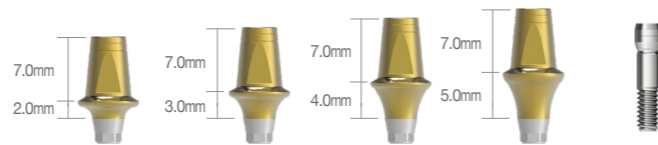

| Abutment Diameter | G/H | P/H | Code No. |
|-------------------|-------|-------|-----------------|
| Ø7.5 | 2.0mm | 7.0mm | DSCAZ75207HHCTS |
| | 3.0mm | | DSCAZ75307HHCTS |
| | 4.0mm | | DSCAZ75407HHCTS |
| | 5.0mm | | DSCAZ75507HHCTS |
| | | | |

※ Set Code(S) : Abutment + Abutment Screw[2DSAS]

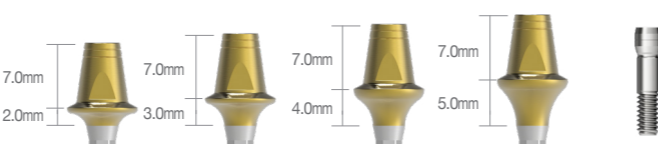

Couple Abutment

Regular / Wide [N-Hex]

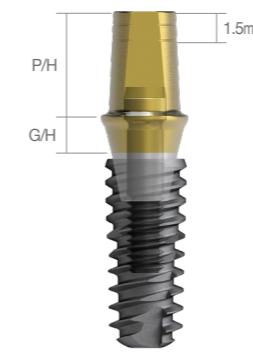

DSCAZ4520NHCT + DSSFR4010

| Abutment Diameter | G/H | P/H | Code No. |
|-------------------|-------|-------|----------------|
| Ø4.5 | 2.0mm | 5.5mm | DSCAZ4520NHCTS |
| | 3.0mm | | DSCAZ4530NHCTS |
| | 4.0mm | | DSCAZ4540NHCTS |
| | 5.0mm | | DSCAZ4550NHCTS |
| | | | |

※ Set Code(S) : Abutment + Abutment Screw[2DSAS]

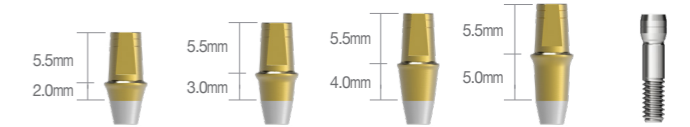

| Abutment Diameter | G/H | P/H | Code No. |
|-------------------|-------|-------|----------------|
| Ø5.5 | 2.0mm | 5.5mm | DSCAZ5520NHCTS |
| | 3.0mm | | DSCAZ5530NHCTS |
| | 4.0mm | | DSCAZ5540NHCTS |
| | 5.0mm | | DSCAZ5550NHCTS |
| | | | |

※ Set Code(S) : Abutment + Abutment Screw[2DSAS]

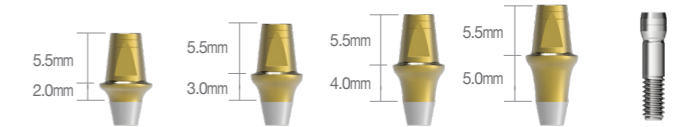

| Abutment Diameter | G/H | P/H | Code No. |
|-------------------|-------|-------|----------------|
| Ø6.5 | 2.0mm | 5.5mm | DSCAZ6520NHCTS |
| | 3.0mm | | DSCAZ6530NHCTS |
| | 4.0mm | | DSCAZ6540NHCTS |
| | 5.0mm | | DSCAZ6550NHCTS |
| | | | |

※ Set Code(S) : Abutment + Abutment Screw[2DSAS]

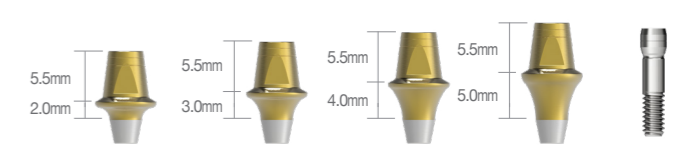

| Abutment Diameter | G/H | P/H | Code No. |
|-------------------|-------|-------|----------------|
| Ø7.5 | 2.0mm | 5.5mm | DSCAZ7520NHCTS |
| | 3.0mm | | DSCAZ7530NHCTS |
| | 4.0mm | | DSCAZ7540NHCTS |
| | 5.0mm | | DSCAZ7550NHCTS |
| | | | |

※ Set Code(S) : Abutment + Abutment Screw[2DSAS]

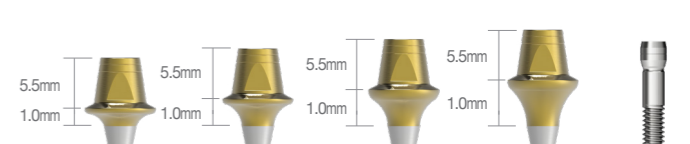

Angled Abutment Regular / Wide [15°]

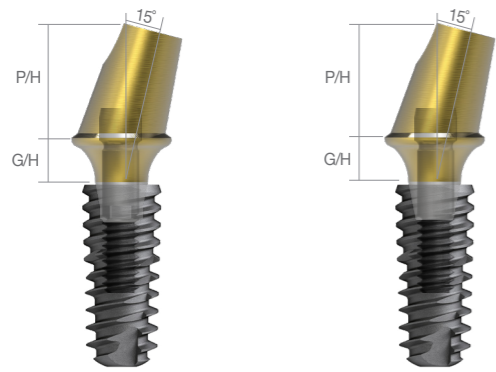

DSAA55152HCTS + DSSFR4010 DSAA551527NHCTS + DSSFR4010

| Abutment Diameter | Angle | G/H | Type | Code No. |
|-------------------|-------|-----|-------|------------------|
| Ø4.5 | 15° | 3mm | Hex | DSAAZ451537HCTS |
| | | | N-Hex | DSAAZ451537NHCTS |
| | | 4mm | Hex | DSAAZ451547HCTS |
| | | | N-Hex | DSAAZ451547NHCTS |

※ Set Code(S) : Abutment + Abutment Screw[2DSAS]

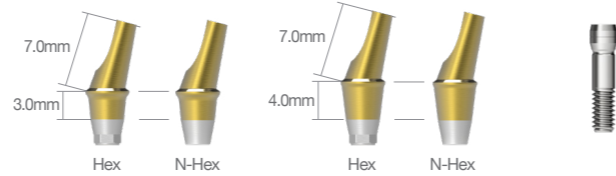

| Abutment Diameter | Angle | G/H | Type | Code No. |
|-------------------|-------|-----|-------|------------------|
| Ø5.5 | 15° | 3mm | Hex | DSAAZ551537HCTS |
| | | | N-Hex | DSAAZ551537NHCTS |
| | | 4mm | Hex | DSAAZ551547HCTS |
| | | | N-Hex | DSAAZ551547NHCTS |

※ Set Code(S) : Abutment + Abutment Screw[2DSAS]

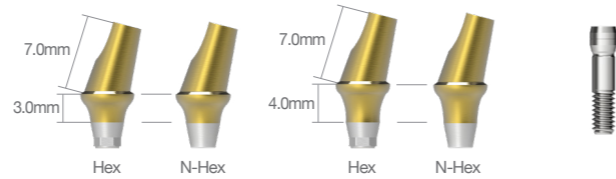

| Abutment Diameter | Angle | G/H | Type | Code No. |
|-------------------|-------|-----|-------|------------------|
| Ø6.5 | 15° | 3mm | Hex | DSAAZ651537HCTS |
| | | | N-Hex | DSAAZ651537NHCTS |
| | | 4mm | Hex | DSAAZ651547HCTS |
| | | | N-Hex | DSAAZ651547NHCTS |

※ Set Code(S) : Abutment + Abutment Screw[2DSAS]

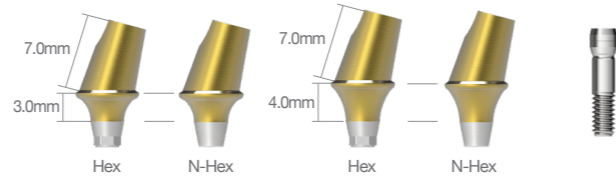

Angled Abutment Regular / Wide [25°]

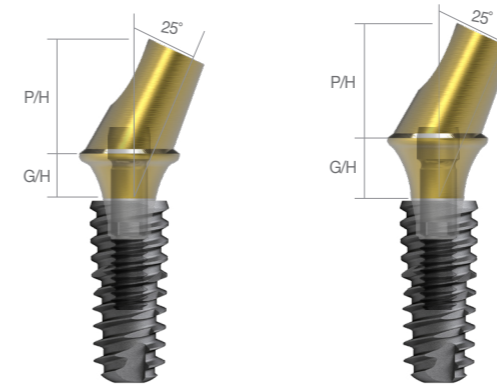

DSAA55252HCTS + DSSFR4010 DSAA55252NCTS + DDSSFR4010

| Abutment Diameter | Angle | G/H | Type | Code No. |
|-------------------|-------|-------|------|-----------------|
| Ø4.5 | 25° | 3.0mm | Hex | DSAAZ452537HCTS |
| | | | Hex | DSAAZ452547HCTS |
| | | 4.0mm | Hex | DSAAZ452537HCTS |
| | | | Hex | DSAAZ452547HCTS |

※ Set Code(S) : Abutment + Abutment Screw[2DSAS]

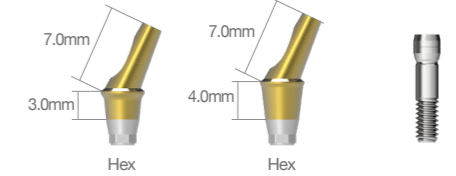

| Abutment Diameter | Angle | G/H | Type | Code No. |
|-------------------|-------|-------|------|-----------------|
| Ø5.5 | 25° | 3.0mm | Hex | DSAAZ552537HCTS |
| | | | Hex | DSAAZ552547HCTS |
| | | 4.0mm | Hex | DSAAZ552537HCTS |
| | | | Hex | DSAAZ552547HCTS |

※ Set Code(S) : Abutment + Abutment Screw[2DSAS]

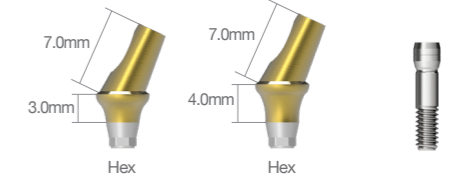

| Abutment Diameter | Angle | G/H | Type | Code No. |
|-------------------|-------|-------|------|-----------------|
| Ø6.5 | 25° | 3.0mm | Hex | DSAAZ652537HCTS |
| | | | Hex | DSAAZ652547HCTS |
| | | 4.0mm | Hex | DSAAZ652537HCTS |
| | | | Hex | DSAAZ652547HCTS |

※ Set Code(S) : Abutment + Abutment Screw[2DSAS]

